



Project Name	
Type	
Part Number	
Quantity	
Notes	



The Ridge RG4 is a modern and stylish surface-mounted wall light that boasts a smooth, angular design, easily installed in a range of height and spacing configurations. Its design and wide beam distribution allows for greater spacing opportunities, maintaining excellent uniformity levels to suit exterior and interior environments.

Features

Lumen Output	700 lm
Power Consumption	10 W
Typical Lifetime	72,000 Hrs (L90 B10)
Input Voltage	International: 220-240 Vac, 50 Hz North America: 120/277 Vac, 60 Hz
IP Rating	IP65
IK Rating	IK9
Compliance	
Color Options	





Hero - LS1282

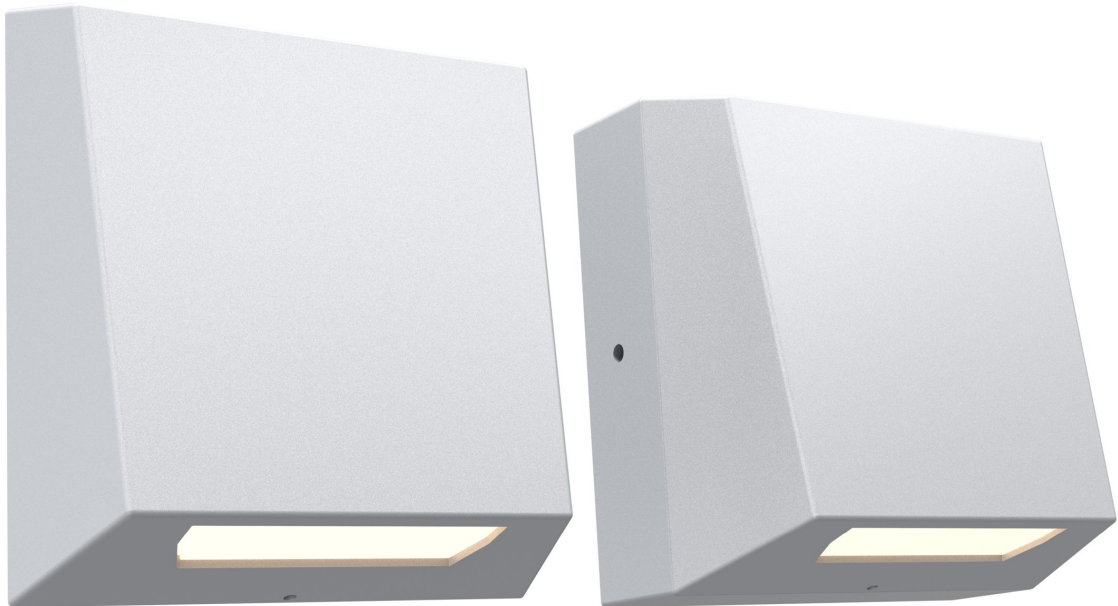

International

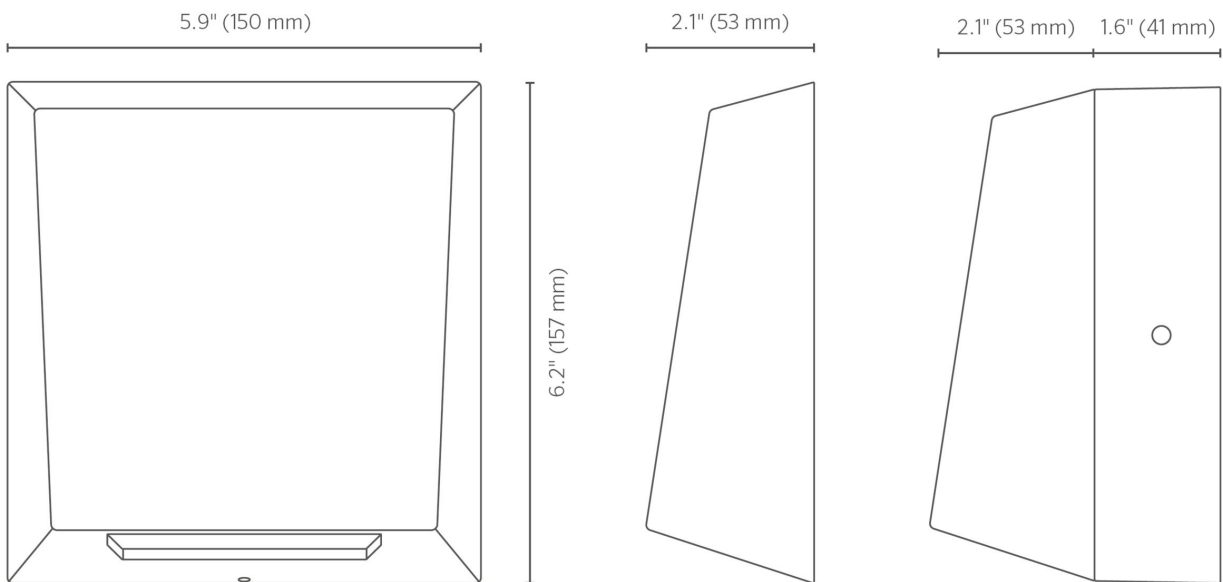

Side View With Wiring Back Box

Configuration

For complete and up-to-date product options, configure the LS1282 using our online [product configurator](#).

LS1282						
Code	Power Consumption	Light Source	Beam Angles	Input Voltage	Control	Finish

Power Consumption

For all PowerSync Controlled Luminaires

10 W (10D)

Light Source

Static White (827)
2,700 K (80 CRI, 3 SDCM)

Static White (830)
3,000K (80 CRI, 3 SDCM)



Static White (840)
4,000 K (80 CRI, 3 SDCM)



Beam Angles

Published angles may vary slightly to photometric data. Please refer to IES files where relevant.

Wide (MD)
100° x 75°

Input Voltage

220 to 240 Vac, 50 Hz (01)
Line Voltage













Control

DALI (DL)

Finish

Custom powder coat colours are available. Please consult factory.

- | | | | | | |
|-------------------------------------------------------------------------------------------------------------------------------------------------------------------------------------------------------|-----------------------------------------------------------------------------------|---------------------------------------------------------------------------------------------------------------|-----------------------------------------------------------------------------------|-----------------------------------------------------------------------------------------------|-------------------------------------------------------------------------------------|
| <input type="checkbox"/> Black (BL)
RAL9004 from RAL
Classic collection
(formerly CB) |  | <input type="checkbox"/> Anthracite Gray (AG)
RAL7016 from RAL
Classic collection |  | <input type="checkbox"/> Basalt Gray (BT)
RAL7012 from RAL
Classic collection |  |
| <input type="checkbox"/> Graphite Gray (GH)
Graphite Gray |  | <input type="checkbox"/> Anodic Silver (SL)
RAL9006 from RAL
Classic collection
(formerly CS) |  | <input type="checkbox"/> White (WT)
RAL9016 from RAL
Classic collection |  |
| <input type="checkbox"/> Dark Bronze (DB)
RAL8019 from RAL
Classic collection |  | <input type="checkbox"/> Latte (LT)
RAL7006 from RAL
Classic collection |  | <input type="checkbox"/> Dark Aluminium (DA)
RAL9007 from RAL
Classic collection |  |
| <input type="checkbox"/> Custom RAL (CC)
A one-off custom color setup fee applies. Click on 'More Info' button to add to your enquiry. Contact Lumascape for volume discount on set-up fee. |  | | | | |



Mounting & Installation

Specify Separately

- Wiring Back Box (LS6336)**
Surface mounted wiring back box.



Custom Color

A one-off setup fee applies for each custom color per order. Add to your enquiry.

- Custom Color Setup Fee (Custom RAL Color)**
Custom RAL colour setup fee

