



The Erden E6 is a shallow-depth medium powered in-ground that combines technology and performance in a modern shallow form factor. Packed with features including **EasyGlow™** visual comfort and **CoolDrive™** thermal management technologies. **PowerSync™** allows for highly granular digital control via common protocols using mains voltage. Available in white, color-changing and tunable white light engines.

Performance

Static White & Color ¹	Lumen Output (lm)	Efficacy (lm/W)	Peak Intensity (cd)
● 2,700 K (80 CRI)	1,990	80	43,400
● 3,000 K (80 CRI)	2,080	84	45,200
○ 3,500 K (80 CRI)	2,245	91	48,900
● 4,000 K (80 CRI)	2,245	91	48,900
● 5,000 K (70 CRI)	2,080	84	45,200

¹ Lumen output values are based on a 10° lens.

Dynamic Color ²	Lumen Output (lm)	Efficacy (lm/W)	Peak Intensity (cd)
● RGBA	1,280	53	22,200
● RGBW (4,000 K) with Royal Blue*	1,260	51	25,400

² Lumen output values are based on a 10° lens.

Tunable White ³	Lumen Output (lm)	Efficacy (lm/W)	Peak Intensity (cd)
● 2,700 K - 6,500 K	2,120	86	46,100

³ Lumen output values are based on a 10° lens.

Beam Angles	10°, 13°, 20°, 26°, 47°, 10° x 40°, 40° x 10°, 20° x 60°, 60° x 20°
-------------	---

* NOTE:

The default RGBW colors have recently changed to the RGBW with Royal Blue (4BW code). These colors will not match existing products with the earlier RGBW with Mid-Blue (4CW code). Contact Lumascape for custom LED Colors.



Products and specifications are subject to change without notice. LS3060-220601

Electrical

LED Power	24 W
Power Consumption	25 W
Lifetime (L70)	>60,000 hrs (B10, L70)
Input Voltage	220-240 Vac, 50 Hz (International) 120/277 Vac, 60 Hz (North America)
Earth Leakage	0.17 mA @ 120 Vac, 0.17 mA @ 240 Vac, 0.17 mA @ 277 Vac
Thermal Management	CoolDrive™ onboard thermal monitoring and control

Control

Interface	Lumascap PowerSync™
Protocols ¹	DMX/RDM, Artnet, PWM ² , 0-10 V (sink or source) ²
PWM Frequency	2 kHz flicker-free dimming to 0.1%
RDM Functionality	PowerSync enabled Lumascap luminaires are shipped with a default RDM personality which provides smooth dimming control. For different dimming characteristics or to enable other special functionalities, the default personality can be changed through industry standard DMX/RDM.
Systems	Range of third party controllers

¹ Some protocols require additional hardware. For details and other available protocols contact Lumascap

² Not available for color-changing

Physical

Housing	Marine-grade 316 stainless-steel housing, high strength glass, teflon coated cover screws and marine-grade 316 stainless-steel cover (polished or brushed finish).
Installation	Pre-Installation blackout for concrete pour, drive-over and general use applications. Mounting collar for decks and grates. Direct burial for landscapes, planters and special applications.
Mounting Accessories	LS6052-K Pre-Installation concrete blackout LS640-2 Mounting collar for decks and grates
Adjustable	-20° to +20° tilt, 360° rotation
Ambient Operating Temperature	-4 °F to 122 °F (-20° C to 50° C)
Surface Temperature	≤149 °F (65 °C)
Weight	8.8 lbs (4.0 kg)
Drive-Over	With OptiClear lens and pre-installation kit (LS6052-K)

Certification & Compliance

IP Rating	IP68
IK Rating	IK10
Static Load Rating	9,259 lbs (4,200 kg)
Environment	Dry, Damp, Wet locations Inherently protected Suitable for use in poured concrete
Certifications	ETL, CE, RCM

Accessories



Technical Drawings

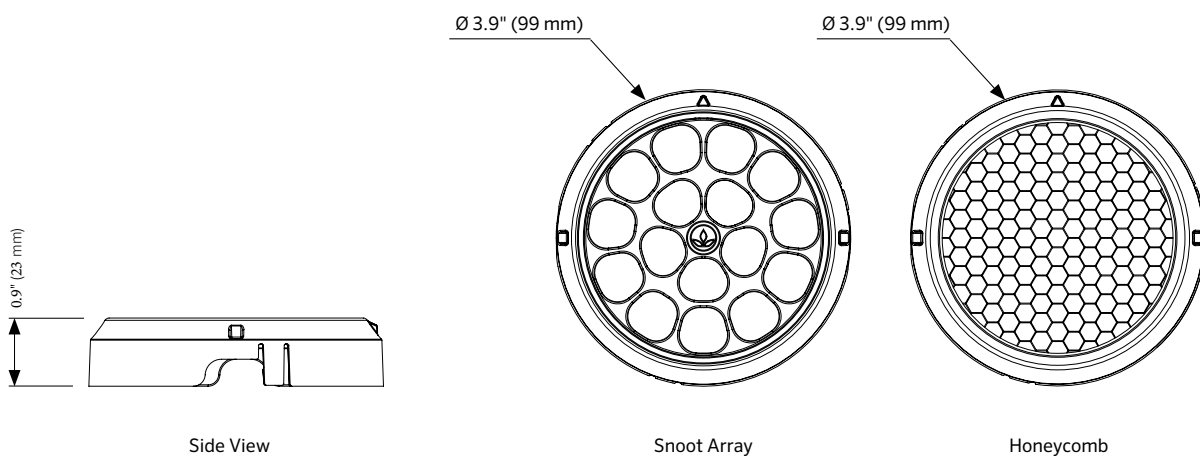

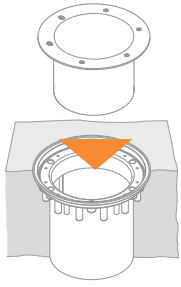

Pre-Installation Blockout

This type of installation requires the **LS6052-K** Pre-Installation Kit (ordered separately), which acts as a concrete blockout and is intended for installation before the luminaire. This method ensures the luminaire itself is not damaged during concreting or other site works.

Used for	Drive over applications General use applications Concrete pour applications where luminaire is to be installed after site work has been completed.
Benefits	Easy removal for servicing
Accessories	LS6052-K Pre-Installation Blockout

Connection type '84'

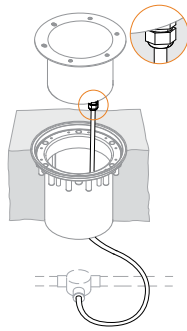

Flexible Cable

For connections to the branch circuit via junction box (by others) or other approved method. 9.8' (3 m) length. For other length options, contact Lumascape.

Connection type '82' North American market only

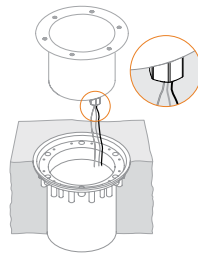

1/2" NPT Adapter

The luminaire is factory-fitted with 6.5' (2.0 m) hookup wire. Ensure terminations can be made within this length. For other length options, consult Lumascape.

Connection type '77'

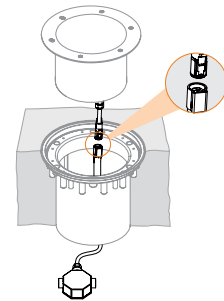

IP68 Connector & Junction Box

The luminaire is fitted with an IP68 connector, which attaches directly to the cable supplied with LS644-K without the use of any tools. The cable is 3' (1 m) in length and is factory assembled with a junction box.

Flush Cover Options

Flush covers for pre-installation, use special seals and support bushes to ensure static loads up to 9,259 lbs (4,200 kg) are properly supported. In order, to achieve this drive-over rating, OptiClear™ or GripGlass™ must be used.

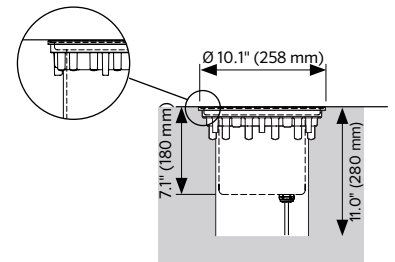
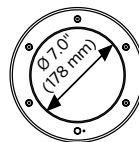

Pre-Installation Blockout Round Flush Cover

- SS316: Polished
- SS316: Brushed

Specification

Use the table below to specify your Pre-Installation Blockout.

LS6052-K	-				
Connection Type		Code			
Flexible cable, single entry, for hardwired installations (International) or Hookup wire and 1/2" NPT (82), single entry, for hard wired installations (North America only)		84			
Flexible cable, single entry, for connectorized installations.		77			
	Input Voltage		Code	Controls	Code
	220-240 Vac, 50 Hz (International)		01	PowerSync	PS
	120/277 Vac, 60 Hz (North America)		09		

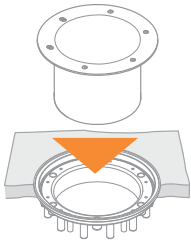

Mounting Collar for decks and grates

This type of installation requires the **LS640-2 Mounting Collar** (ordered separately), to support the installation in decks, grates and hollow floors with sufficient ventilation.

Not available in North America.

Used for	Decks and grates Hollow floors with sufficient ventilation
Benefits	Easy installation in decks, grates and hollow floors
Accessories	LS640-2 Mounting Collar

Connection type '84'

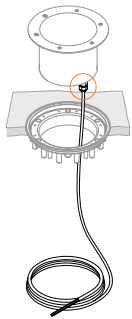

Flexible Cable

For connections to the branch circuit via junction box (by others) or other approved method. 6.5' (2 m) length. For other length options, contact Lumascape.

Specification

Use the table below to specify your Mounting Collar.

	LS640-2
Connection Type	Code
Mounting Collar for use with hard wire connections only	LS640-2

Flush Cover Options

Flush covers for mounting collar use special seals and support brushes.



Pre-Installation Blockout Round Flush Cover

- SS316: Polished
- SS316: Brushed

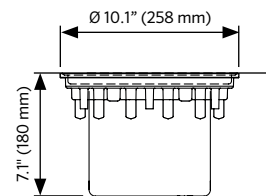
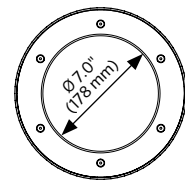

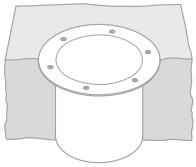

Direct Burial

Luminaire is put directly into soil or concrete.

Used for	Landscaping areas Applications where depth is restricted Rate for use in concrete pour applications Economical option
Benefits	Allows for maximum heat dissipation
Restrictions	Not as easy to remove for service as pre-install version Not suitable for drive-over (requires pre-installation) Not available with Connection Type 77 (requires pre-installation) Connection Type 82 only available for North American market.

Connection type '84'

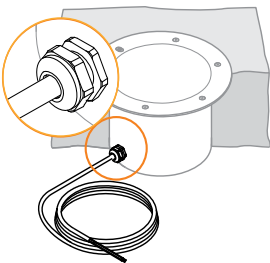

Flexible Cable

For connections to the branch circuit via junction box (by others) or other approved method. 9.8' (3 m) length. For other length options, contact Lumascape.

Connection type '82'
North American Market only

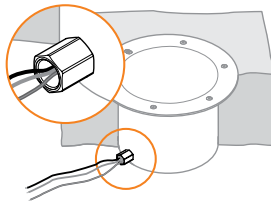

1/2" NPT Adapter

The luminaire is factory-fitted with 6.5' (2.0 m) hookup wire. Ensure terminations can be made within this length. For other length options, contact Lumascape.

Recessed Cover Options

Use recessed cover for installation in soil, grass, pavers and other uneven surfaces where no cover overhang is required.



Round Recessed Cover

- SS316: Polished
- SS316: Brushed

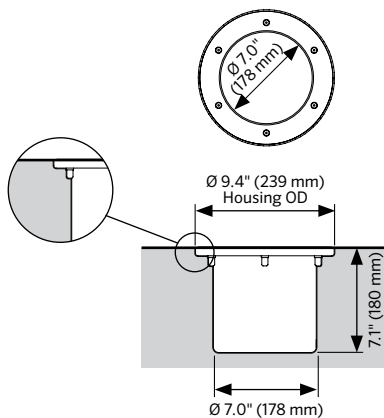

Flush Cover Options

Use flush covers for installation in fine finished surfaces such as granite and marble. Can also be used in some suspended applications to conceal gaps between the luminaire and the surrounding surface.



Round Flush Cover

- SS316: Polished
- SS316: Brushed

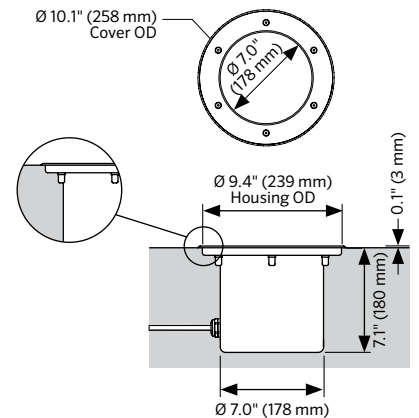

Network Topology - Line Voltage 220-240 Vac, 120/277 Vac Dimmable via PowerSync®

PowerSync Topology 1 - Single Trunk Cable

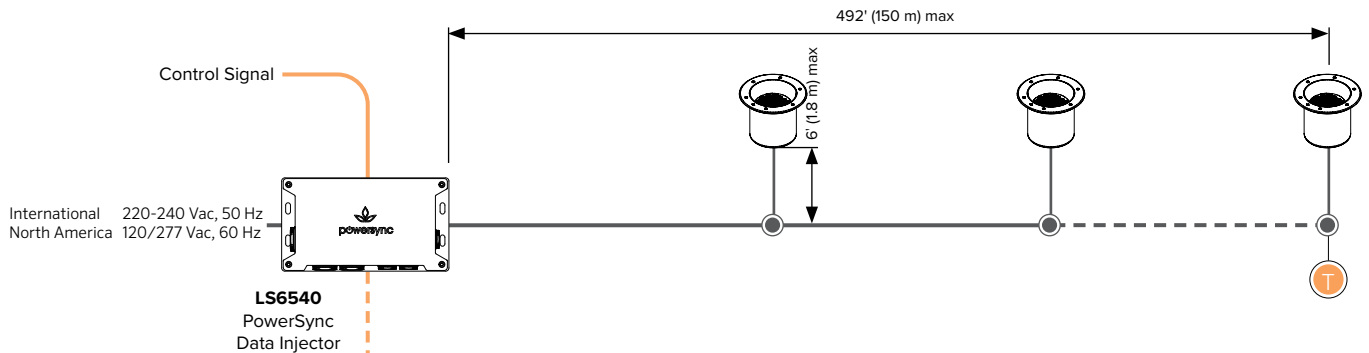

PowerSync Topology 2 - Single Trunk Cable

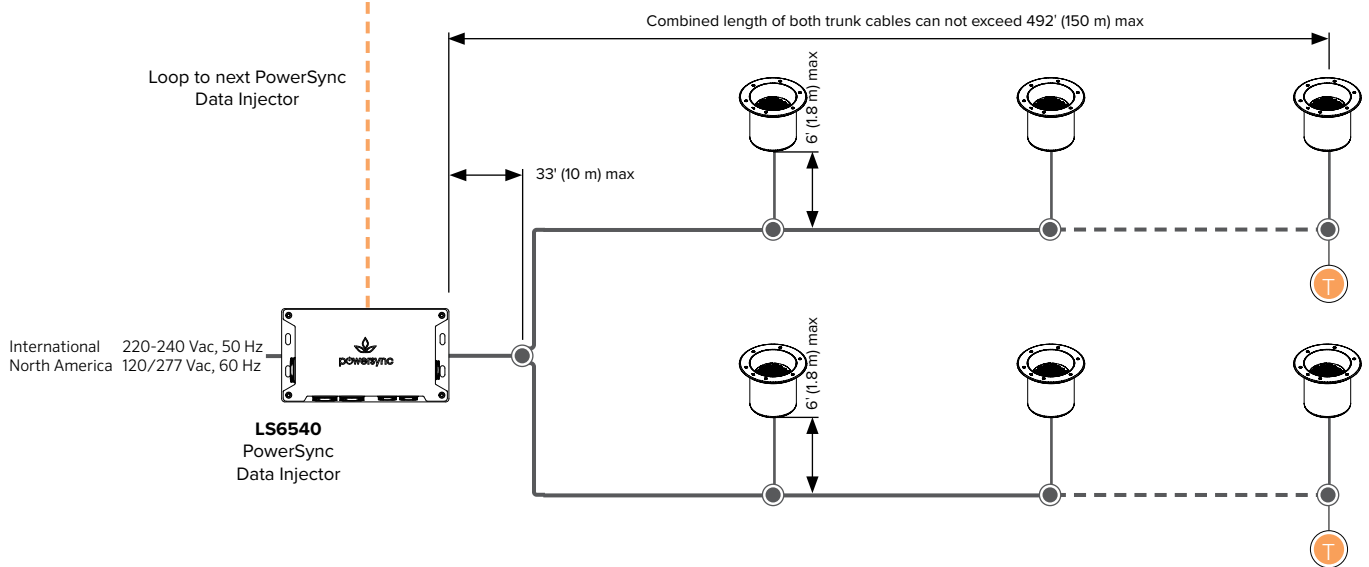

Up to 45 luminaires per run under the following conditions:

- Max total cable run length 492' (150 m) in up to two trunk cables
- For run lengths in excess of 100' (30 m), the data wire gauge cannot exceed 14 AWG (2.5 mm²)
- For run lengths up to 100' (30 m), the data wire gauge is not governed
- Refer to Maximum Circuit Load table for circuit limitations
- Always observe local electrical codes for branch circuit current limitations

T Terminator
Use PowerSync terminator, supplied with LS6540, to terminate last luminaire in chain at junction box.

● Connection Type
Circuits are configured as hardwired. For details consult installation instructions and comply with local electrical codes.

Maximum Circuit Load

Maximum Number of Interconnected Luminaires		
Voltage	12A	16A
120V	41	45
240V	45	45
277V	45	45

Refer to PowerSync® installation instructions for maximum distance information and topology options.
Above circuit loading limits are based on maximum circuit current capacity. Cumulative earth leakage and voltage drop may need to be calculated.
For non-continuous runs contact Lumascape for more details.

Connectorized Accessories

Terminator (Hardwired Installation)

Used in hardwired PowerSync™ installations.

Terminator	Code
DMX Terminator Hardwired (CCC, CE, UL)	LS6407
Terminator Hardwired, Line Voltage 220-240 Vac (CCC, CE)	LS6406-01
Terminator Hardwired, Line Voltage 120/277 Vac (UL)	LS6406-09

NOTE:

PowerSync Terminator ships with every LS6540. Order separately for spare parts only.

PowerSync Line Voltage 220/240 Vac, 120/277 Vac Data Injector

Combines the convenience of standard wiring methods to translate control signals into a digital format that can be transmitted over standard copper wire. This allows highly granular addressing and high-speed digital control of every luminaire, using only four wires and accepts a growing list of standard protocols (0-10V, DMX / RDM), for simple integration with a wide selection of control systems using these industry standard protocols.



LS6540		-		2D			
Product	Code	Input Voltage	Code	Control	Code	Finish	Code
Data Injector PS4	LS6540	220-240 Vac, 50 Hz (International)	01	DMX/RDM, 0-10 V Input	2D	Black	BL
		120/277 Vac, 60 Hz (North America)	09			Anthracite Gray	AG
						Basalt Gray	BT
						Graphite Gray	GH
						Anodic Silver	SL
						White	WT
						Dark Bronze	DB
						Latte	LT
						Dark Aluminum	DA
						Custom RAL	CC ¹

¹RAL color required

NOTE:

PowerSync Data Injector ships with three (3) hardwired terminators and one (1) hardwired DMX terminator.

Luminaire Wire Colours & Designations

Line Voltage 220-240 Vac - International

Designation	Color
Line	Brown
Neutral	Blue
Ground/Earth	Green / Yellow
Data	Black

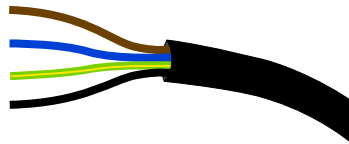

Line Voltage 120/277 Vac - North America

Designation	Color
Line	Black
Neutral	White
Ground/Earth	Green / Yellow
Data	Orange

